

TECHNICAL ASSISTANCE

Regarding technical issues, please visit www.alpha-gamer.com or contact us through support@alpha-gamer.com.

ALPHA  GAMER

STATEMENT OF COMPLIANCE WITH EUROPEAN UNION DIRECTIVES

Alpha Gamer declares that this product is in compliance with the essential requirements and other relevant provisions from the following Directives: 2014/30/EU; 2011/65/EU, as applicable. The technical documentation required by the Conformity Evaluation process is in Alpha Gamer's possession and can be requested through support@alpha-gamer.com.



DISPOSAL OF BATTERIES AND ELECTRICAL OR ELECTRONIC EQUIPMENT WASTE

The existence of this symbol on the product, batteries or respective packaging, signifies that this product and the contained batteries can not be disposed as domestic waste. It is the user's responsibility to deliver this product at a batteries, electrical or electronic recycling pick-up point.

The pick-up and separate recycling contributes for the preservation of natural resources and suppresses potential negative consequences for the human health and the environment resultant of inadequate disposal of dangerous substances contained in batteries and electrical or electronic equipment.

For additional informations regarding batteries, electrical or electronic recycling pick-up points, please contact your local municipal services.

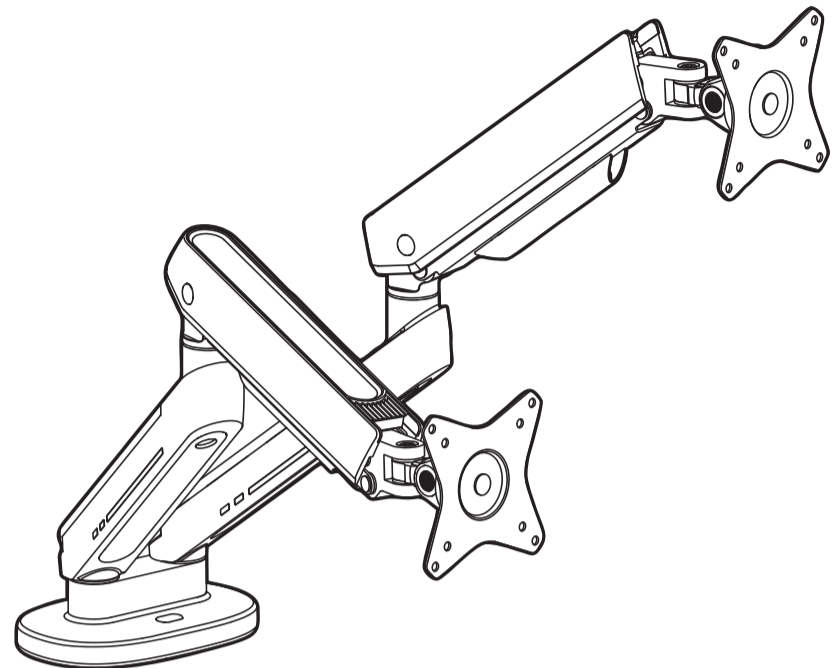

NAVI DUAL RGB

MONITOR ARM

ASSEMBLY GUIDE

6

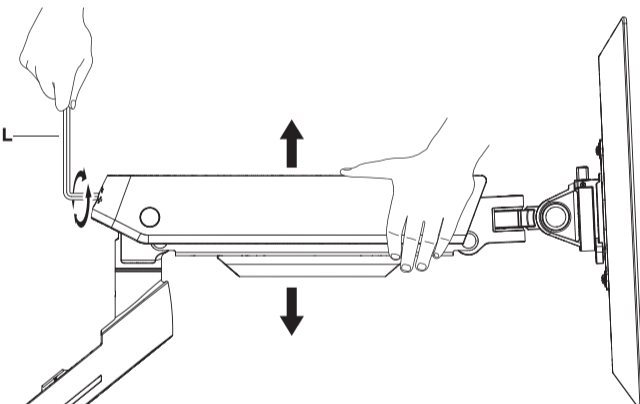

To properly balance the arm with the monitor mounted, adjust the spring tension using the supplied Allen Key as follows:

First, position and firmly hold the arm horizontally as shown. Ask for assistance should you require it.

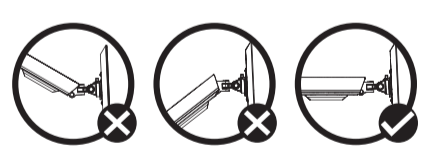

CAUTION: To avoid damage to monitors or arm, always keep the arm in a horizontal position while making adjustments. Again, ask for assistance if required.

If the arm **drops**, turn the adjustment screw clockwise until it stays in a horizontal position.

If the arm **rises**, turn the adjustment screw counter-clockwise until it stays in a horizontal position.

CAUTION: Do not over tighten the screws.

7

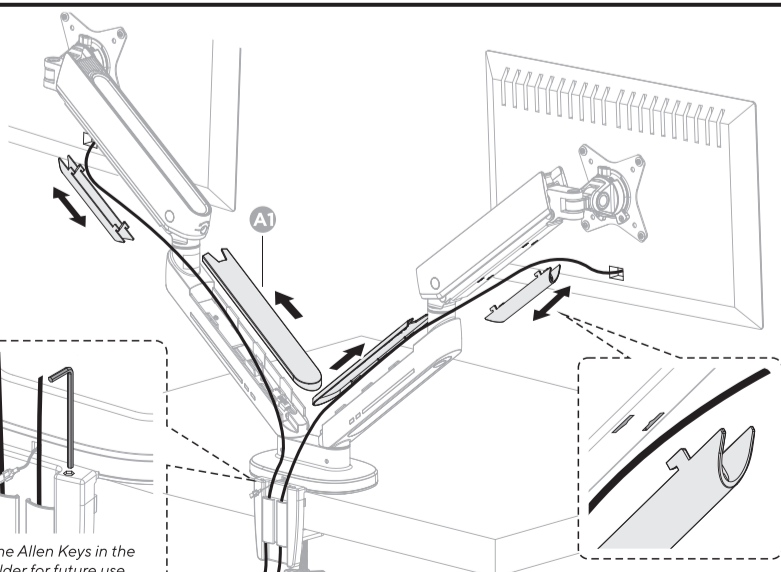

Store the Allen Keys in the tool holder for future use.

8

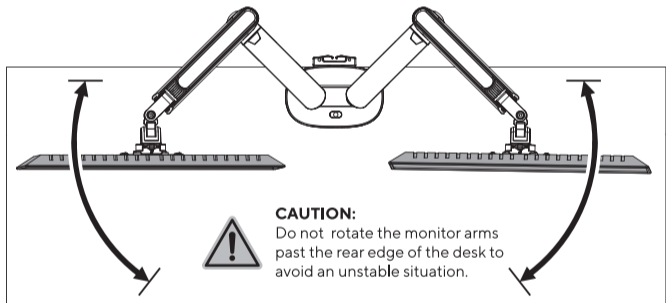

CAUTION: Do not rotate the monitor arms past the rear edge of the desk to avoid an unstable situation.

Note: If the monitor does not stop at the desired position, tighten the screws clockwise/counter-clockwise to balance the weight.

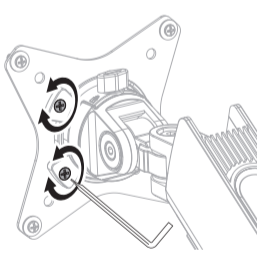

Note: If the monitor does not stop at the desired position, tighten the screws clockwise/counter-clockwise to balance the weight.

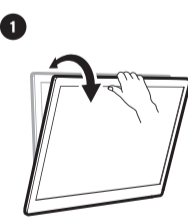
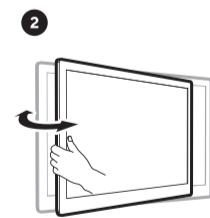
RGB functions

- 1. On/Off:** Press and hold the button for 2 seconds.
- 2. Light mode switch:** Quick press the button to change RGB light mode (20 different modes).
- 3. Random color mode:** Quick double press the button.

